

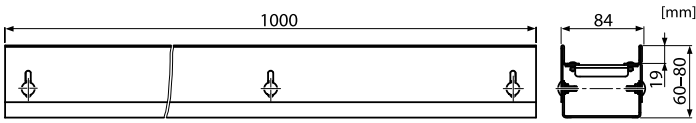

ADZ131V ■ ADZ132V ■ ADZ331V ■ ADZ332V ■ ADZ351V ■ ADZ352V

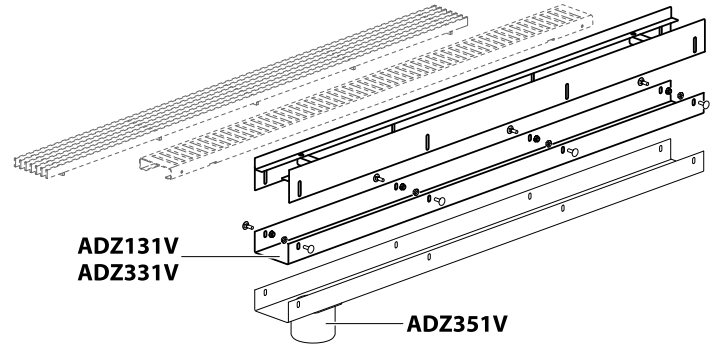

ADZ131V [1] ADZ331V [2]



ADZ131V
ADZ331V

ADZ351V

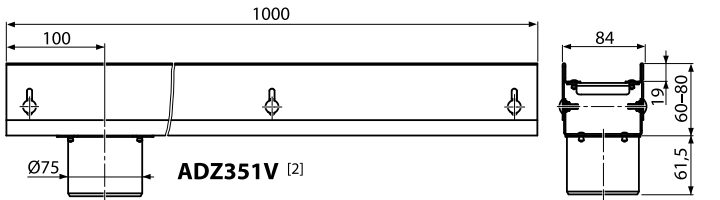

ADZ351V [2]

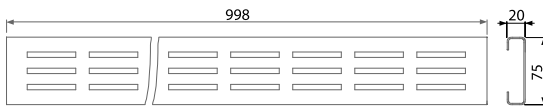
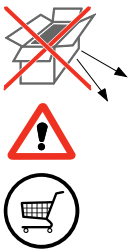

ADZ-R101 [1] ADZ-R301 [2]

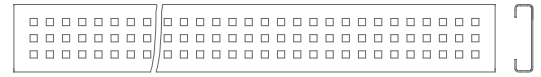

ADZ-R103 [1] ADZ-R303 [2]

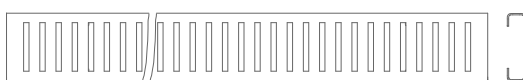

ADZ-R102 [1] ADZ-R302 [2]



ADZ-R104 [1] ADZ-R304 [2]

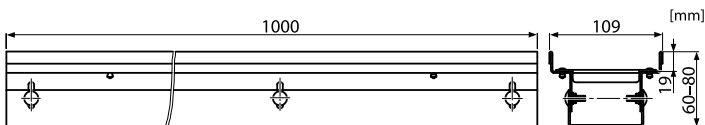

ADZ132V [1] ADZ332V [2]

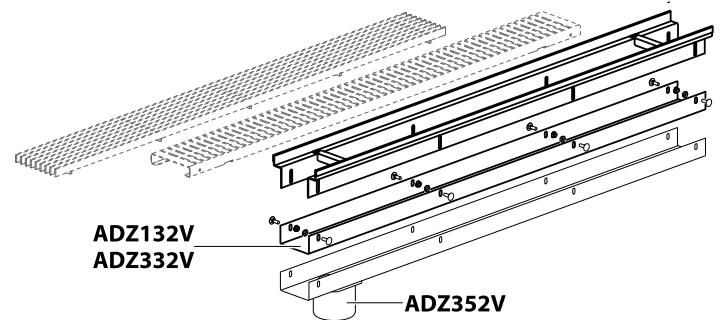

ADZ132V
ADZ332V

ADZ352V

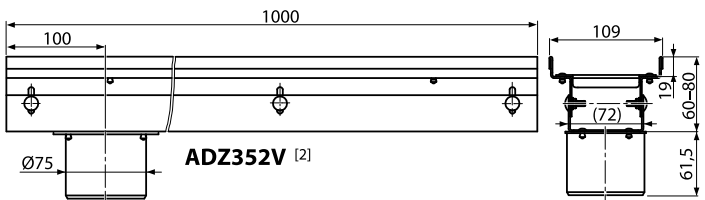

ADZ352V [2]

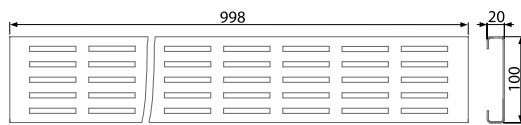
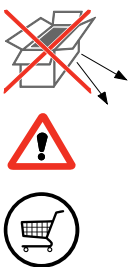

ADZ-R121 [1] ADZ-R321 [2]

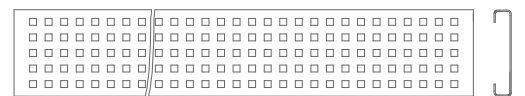

ADZ-R123 [1] ADZ-R323 [2]

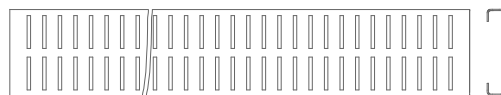

ADZ-R122 [1] ADZ-R322 [2]

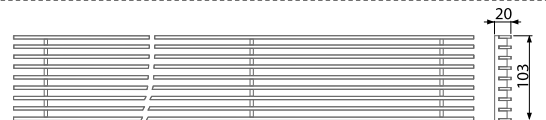

ADZ-R124 [1] ADZ-R324 [2]

[1] pozink | galvanizad | гальванизированный | galvanisiert | ocynowane | galvanizat | galvanizált | zincato | galvanizado | galvanisé | verzinkt | cinkuotas | cinkots | galvaniseeritud | поцинкована | γαλβανισμένο | pocinkana | galvaniziran | pocinkovano

[2] nerez | stainless steel | нержавеющая сталь | Edelstahl | stal nierdzewna | Inox | rozsdamentes acél | acciaio inossidabile | acero inoxidable | aço inoxidável | acier inoxydable | roestvrij staal | roostevaba teras | nerušéjoša tērauda | roostevaba teras | neružđaema stolmana | από ανοξείδωτο χάλυβα | iz nerjavečega jekla | nehrdajuci čelik | nehrdajúci čelik

1

