

APV102

Floor drain 105×105/50 mm side outlet, stainless steel grid, wet odour trap

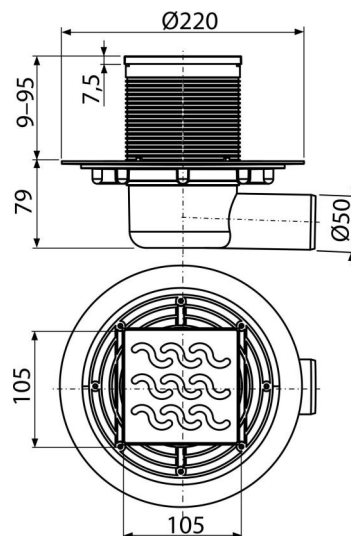

Application

For wheelchair access
For the interior, where will be frequent use associated with the regular water runoff into the floor drain (bathrooms)

Features

- Side connection to waste Ø50 mm
- Compatibility with floor drains parts including wet, dry and combined odour trap SMART
- Solid brass grid 102×102×4 mm
- Material: stainless steel AISI 304, DIN 1.4301
- Material: polypropylene resistant to mechanical, chemical and thermal damage
- Mechanically cleanable trap up to the waste pipe
- Wide insulation collar for connection to waterproofing construction
- Wet odour trap prevents the penetration of odours from the sewer
- Height adjustable throat 9–95 mm

Scope of supply

- Design stainless steel grid
- Floor drain throat 105×105 mm
- Seal kit
- Floor drain body Ø50 mm, side outlet
- Wet odour trap

Order number, Logistic information

Code	EAN	Weight (piece packing palett)	Dimensions (piece packing)	Quantity (packing palett)
APV102	8594045930412	0,97 7,79 175,7 kg	230×190×230 780×245×475 mm	8 160 pcs

Warranty
2/6 years *

Norms
EN 1253

Technical specifications

- Total installation height 88-174 mm
- Resistance of odour trap against the pressure 480 Pa
- Waste pipe diameter 50 mm
- Flow of the inlet grid 46 l/min
- Load class K3 300 kg
- Odour trap 51 mm