

# M910

Noise insulation for wall-hung WC and bidets with accessories including cover cap (white)

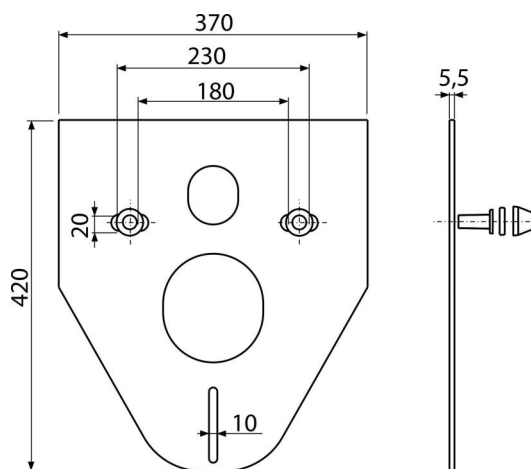
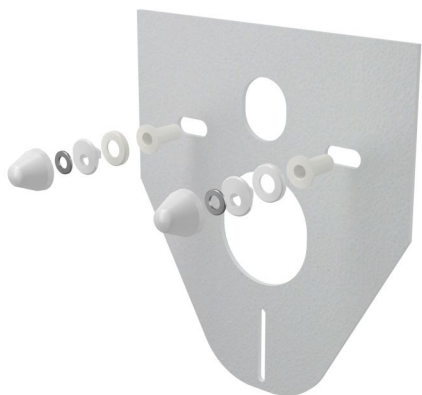

### Application

For mounting ceramics with connecting pitches 180 mm and 230 mm  
To compensate the inequalities between the ceramics and the tiles  
For WC and wall-hung bidet

### Features

- No memory effect
- Simply trimable to the shape of the used ceramics
- Material: XPLE
- Interrupts the transmission of vibrations between the wall and the ceramics

### Scope of supply

- Insulation board
- Cover 2 pcs (white)
- Washer for insulation boards 2 pcs
- Nut washer 2 pcs
- Insulation board insert 2 pcs

### Order number, Logistic information

Code	EAN	Weight (piece   packing   palett)	Dimensions (piece   packing)	Quantity (packing   palett)
M910	8594045937749	0,10   4,99   99,8 kg	420x370x5,5   590x430x390 mm	50   800 pcs

Warranty  
2/2 years \*

Customs code  
39269097