

A800-DN50

Sink waste and pipe trap with stainless steel grid DN70

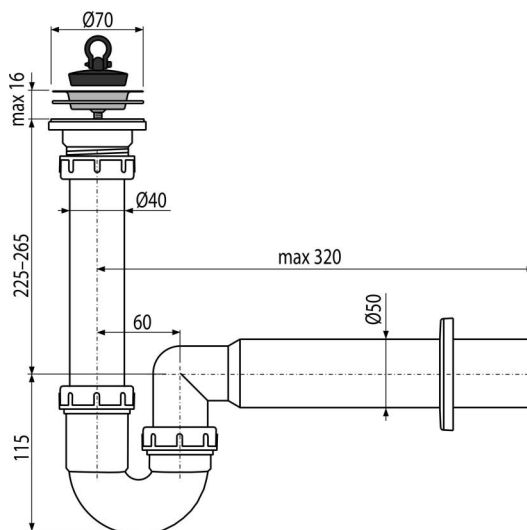

Application

For sink

Features

- Material: polypropylene
- Connection to waste pipe Ø50 mm

Scope of supply

- Stainless steel outlet grid
- Plastic rosette
- Waste and trap body
- PVC plug

Order number, Logistic information

Code	EAN	Weight (piece packing palett)	Dimensions (piece packing)	Quantity (packing palett)
A800-DN50	8594045938203	50 mm 0,35 5,25 166,9 kg	300x90x200 590x240x390 mm	15 420 pcs

Warranty

2/3 years *

Norms

EN 274

Technical specifications

- Flow rate 60 l/min
- Thermal resistance 95 °C
- Odour trap 64 mm