

APZ5-EDEN-950 Spa

Waste system for installation in walls, cover stainless steel-polished

Application

For wheelchair access
 For installation into the wall
 For indoor use
 Suitable for areas with movement of large number of people – swimming pools, spa, wellness center

Features

- Easily removable cover – stainless steel polished
- The collar and trap are protected by foil, and the channel itself by a polystyrene insert
- Trap material: polypropylene
- Material of drainage channel: stainless steel AISI 304, DIN 1.4301
- Mechanically cleanable trap up to the waste pipe
- Possibility to buy a combined odour trap
- Possibility to order with LED backlight
- Linear drain from stainless steel (hardened by pickling, passivation and electrochemical polishing)
- Self-adhesive tape for quality waterproofing
- Trap firmly connected to the drain – 100% waterproofing
- Installation depth 64 mm
- The system is placed outside the area of mechanical stress
- Water flows into the drain only between the edge of the floor tiles and the cover of the drain system
- The high flow rate is achieved due to the double compartment trap system
- 25 years guarantee

Scope of supply

- Fixing hardware for anchoring the adjustable legs: screw M6x12 – 2 pcs
- Anchoring set: screw Ø6x50 – 2 pcs, dowel Ø10 – 2 pcs, screw Ø4.2x38 – 3 pcs, dowel Ø8 – 3 pcs
- Installation channel cover
- Stainless steel design grid EDEN polished
- The collar and the odour trap inlet are covered by the protective foil
- Self-adhesive waterproofing tape
- The shower drain is assembled with the odour trap

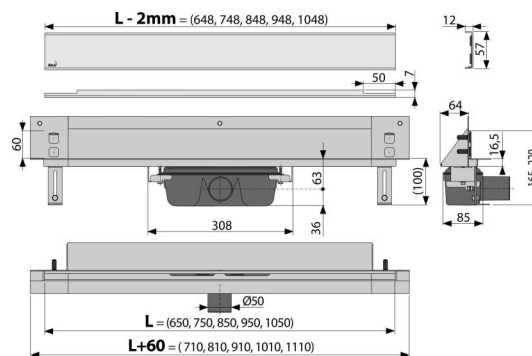

Order number, Logistic information

Code	EAN	Weight (piece packing palett)	Dimensions (piece packing)	Quantity (packing palett)
APZ5-EDEN-950	8595580500061	5,48 43,83 151,5 kg	1020x160x205 1020x700x375 mm	8 24 pcs

Warranty

2/25 years * Norms EN 1253

Technical specifications

- Total installation height 165-220 mm
- Minimum thickness of concrete 100 mm
- Resistance of odour trap against the pressure 982 Pa
- Waste pipe diameter 50 mm
- Flow rate 60-68,8 l/min
- Cover width 60 mm
- Installation depth 64 mm
- Odour trap 50 mm