

A55KM-120

Bath pop-up waste and trap, metal

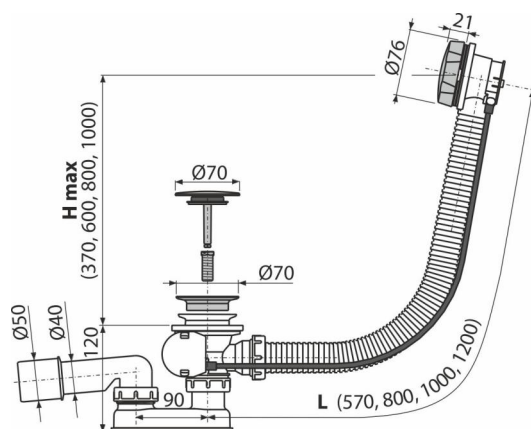

Application

To drain the water from the bath to the waste
For bathtubs with drain outlet Ø52 mm
For standard size bathtubs

Features

- The length of the bathtub trap 120 cm
- Overflow flexi pipe
- Closing waste by pop-up mechanism
- Bath waste and overflow system
- Wet odour trap with swivel elbow

Scope of supply

- Assembly kit
- Chrome-plated metal control knob
- Chrome-plated stainless steel outlet grid
- Chrome-plated plastic plug
- Waste and trap body with overflow
- Profiled seal
- Odour trap of polypropylene, thermally and chemically resistant, longitudinally welded

Order number, Logistic information

Code	EAN	Weight (piece packing palett)	Dimensions (piece packing)	Quantity (packing palett)
A55KM-120	8595580501129	120 mm 0,86 10,30 184,8 kg	380×85×145 595×435×395 mm	12 192 pcs

Warranty

2/3 years *

Norms

EN 274

Technical specifications

- Resistance of odour trap against the pressure 588 Pa
- Flow rate 51,6 l/min
- Overflow flow rate 42 l/min
- Thermal resistance 95 °C
- Odour trap 50 mm