

# APZ106-550 Professional Low

## Shower drain with an edge for full grids

### Application

- For wheelchair access
- For sites with limited floor height
- For drainage of floor-level showers
- For installation into open spaces or near the wall of the shower area
- For full grids, grid FLOOR for embedding tiles and prismatic grid GAP
- For indoor use

### Features

- The collar and trap are protected by foil, and the channel itself by a polystyrene insert
- Trap material: polypropylene
- Shower drain material: stainless steel 2 mm, AISI 304, DIN 1.4301
- Mechanically cleanable trap up to the waste pipe
- Linear drain from stainless steel (hardened by pickling, passivation and electrochemical polishing)
- For inserting full grids – stainless steel, tempered glass, synthetic stone, grid for embedding tiles and prismatic grid
- Self-adhesive tape for quality waterproofing
- Trap firmly connected to the drain – 100% waterproofing
- Installation height from 65 mm
- Adjustable height
- The high flow rate is achieved due to the double compartment trap system
- 25 years guarantee

### Scope of supply

- Fixation set: screws  $\varnothing 6 \times 50$  – 2 pcs, dowels  $\varnothing 10$  – 2 pcs
- Installation trough cover - polystyrene
- Protective foil covering for the drain edges and odour trap
- Protective film for trap inlet
- Self-adhesive waterproofing tape
- The shower drain is assembled with the odour trap

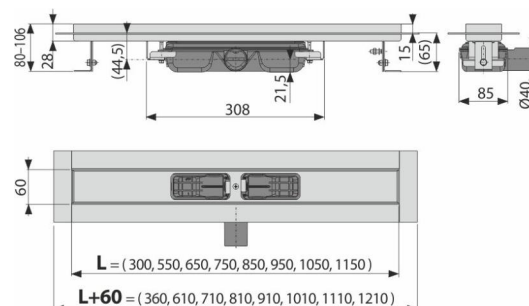

### Order number, Logistic information

Code	EAN	Weight (piece   packing   palett)	Dimensions (piece   packing)	Quantity (packing   palett)
APZ106-550	8595580505158	550 mm 2,92   35,02   125,1 kg	620×135×170   mm	12   36 pcs

### Warranty

2/25 years \*

### Technical specifications

- Total installation height 80-106 mm
- Minimum thickness of concrete 65 mm
- Resistance of odour trap against the pressure 575 Pa
- Waste pipe diameter 40 mm
- Flow rate 35 l/min
- Load class K3 300 kg
- Odour trap 28 mm