

APZ6-550 Professional

Shower drain with an edge for full grids

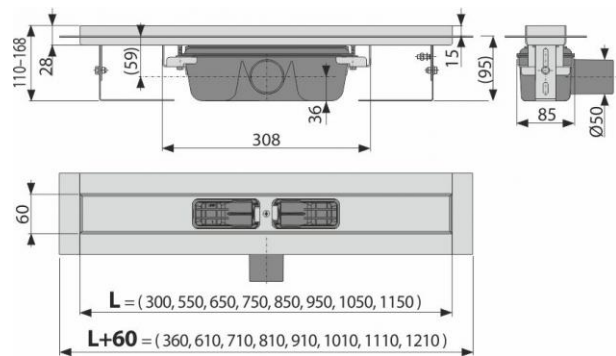

Application

- For indoor use
- For drainage of floor-level showers
- For installation into open spaces or near the wall of the shower area
- For full grids, grid FLOOR for embedding tiles and prismatic grid GAP
- For wheelchair access

Features

- Linear drain from stainless steel (hardened by pickling, passivation and electrochemical polishing)
- For inserting full grids - stainless steel, tempered glass, synthetic stone, grid for embedding tiles and prismatic grid
- Installation height from 95 mm
- Adjustable height
- The trap is firmly connected to the drain channel - 100% waterproofing
- Self-adhesive waterproofing tape for quality waterproofing
- Mechanically cleanable trap up to the waste pipe
- The collar and trap are protected by foil, and the channel itself by a polystyrene insert
- The high flow rate is achieved due to the double compartment trap system
- Possibility to buy a combined odour trap
- 25 years guarantee
- Material of drainage channel: stainless steel AISI 304, DIN 1.4301
- Trap material: polypropylene

Norms

EN 1253

Scope of supply

- The shower drain is assembled with the odour trap
- Anchoring set: screw $\text{Ø}6 \times 50$ - 2 pcs, dowel $\text{Ø}10$ - 2 pcs
- Self-adhesive waterproofing tape

APZ6-550 Professional

Shower drain with an edge for full grids

Scope of supply

- The collar and the odour trap inlet are covered by the protective foil
- Installation channel cover
- Anchoring set for fixing the adjustable legs: screw M6×12 - 2 pcs

Order number

Code	EAN
APZ6-550	8595580505431

Technical specifications

- Odour trap 50 mm
- Flow rate 60-68,8 l/min
- Resistance of odour trap against the pressure 982 Pa
- Waste pipe diameter 50 mm
- Minimum thickness of concrete 95 mm
- Total installation height 110-168 mm
- Load class K3 300 kg

Guarantee

2/25 years

Customs code

39229000

Weight - piece	3.036 kg
Weight - packing	0. kg
Weight - pallet	kg
Dimensions - piece	620×135×170 mm
Dimensions - packing	mm
Quantity - packing	12 pcs
Quantity - Palett	36 pcs