

APZ6-850 Professional

Shower drain with an edge for full grids

Application

For wheelchair access
 For drainage of floor-level showers
 For installation into open spaces or near the wall of the shower area
 For full grids, grid FLOOR for embedding tiles and prismatic grid GAP
 For indoor use

Features

- The collar and trap are protected by foil, and the channel itself by a polystyrene insert
- Trap material: polypropylene
- Material of drainage channel: stainless steel AISI 304, DIN 1.4301
- Mechanically cleanable trap up to the waste pipe
- Possibility to buy a combined odour trap
- Linear drain from stainless steel (hardened by pickling, passivation and electrochemical polishing)
- For inserting full grids – stainless steel, tempered glass, synthetic stone, grid for embedding tiles and prismatic grid
- Self-adhesive tape for quality waterproofing
- Trap firmly connected to the drain – 100% waterproofing
- Installation height from 95 mm
- Adjustable height
- The high flow rate is achieved due to the double compartment trap system
- 25 years guarantee

Scope of supply

- Fixing hardware for anchoring the adjustable legs: screw M6x12 – 2 pcs
- Anchoring set: screw Ø6x50 – 2 pcs, dowel Ø10 – 2 pcs, screw Ø4.2x38 – 3 pcs, dowel Ø8 – 3 pcs
- Installation channel cover
- The collar and the odour trap inlet are covered by the protective foil
- Self-adhesive waterproofing tape
- The shower drain is assembled with the odour trap

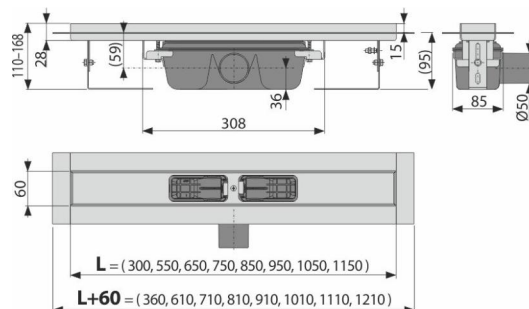

Order number, Logistic information

Code	EAN	Weight (piece packing palett)	Dimensions (piece packing)	Quantity (packing palett)
APZ6-850	8595580505493	850 mm 3,90 46,84 160,5 kg	920x135x170 mm	12 36 pcs

Warranty 2/25 years *
Norms EN 1253

Technical specifications

- Total installation height 110-168 mm
- Minimum thickness of concrete 95 mm
- Resistance of odour trap against the pressure 982 Pa
- Waste pipe diameter 50 mm
- Flow rate 60-68,8 l/min
- Load class K3 300 kg
- Odour trap 50 mm