

CPZ LOW-850

Linear shower drain

Application

- For wheelchair access
- For sites with limited floor height
- For drainage of floor-level showers
- For installation into open spaces or near the wall of the shower area
- For full grids, grid FLOOR for embedding tiles and prismatic grid GAP
- For indoor use

Features

- The collar and trap are protected by foil, and the channel itself by a polystyrene insert
- Trap material: polypropylene
- Material of drainage channel: stainless steel AISI 304, DIN 1.4301
- Mechanically cleanable trap up to the waste pipe
- Linear drain from stainless steel (hardened by pickling, passivation and electrochemical polishing)
- For inserting full grids – stainless steel, tempered glass, synthetic stone, grid for embedding tiles and prismatic grid
- Self-adhesive tape for quality waterproofing
- Trap firmly connected to the drain – 100% waterproofing
- Installation height from 65 mm
- Adjustable height
- The high flow rate is achieved due to the double compartment trap system
- 25 years guarantee

Scope of supply

- Fixing hardware for anchoring the adjustable legs: screw M6×12 – 2 pcs
- Fixation set: screws Ø6×50 – 2 pcs, dowels Ø10 – 2 pcs
- Installation channel cover
- The collar and the odour trap inlet are covered by the protective foil
- Self-adhesive waterproofing tape
- The shower drain is assembled with the odour trap

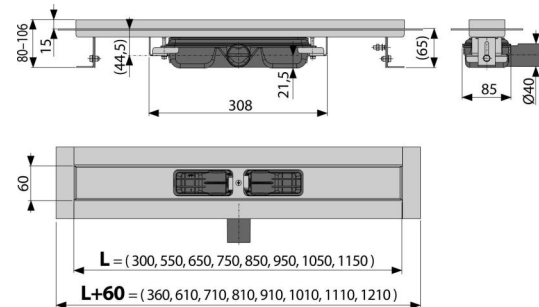

Order number, Logistic information

Code	EAN	Weight (piece packing palett)	Dimensions (piece packing)	Quantity (packing palett)
CPZ LOW-850	8595580506841	3,60 43,14 149,4 kg	920×135×170 mm	12 36 pcs
Warranty 2/25 years	Customs code 39229000	Norms EN 1253		

Technical specifications

- Total installation height 80-106 mm
- Minimum thickness of concrete 65 mm
- Resistance of odour trap against the pressure 575 Pa
- Waste pipe diameter 40 mm
- Flow rate 32 l/min
- Load class K3 300 kg
- Odour trap 28 mm