

A565CRM3-120

Bath pop-up waste and trap, with overflow filler, for thick-walled bathtubs, chrome

Application

- For filling the bath by overflow
- To drain the water from the bath to the waste
- For thick-walled bathtubs
- For bathtubs with drain outlet Ø52 mm

Features

- Side G1/2" fitting for filling of pre-mixed water
- The length of the bathtub trap 120 cm
- Overflow flexi pipe
- Easy installation with three stainless steel screws
- Space-saving design in the bathtub – visible only control knob
- Control shaft made of stainless steel
- Aerator Neoperl – easy access and exchange
- Closing waste by pop-up mechanism
- Bath overflow filler, waste and trap system
- Water does not flow down on the side of the bathtub and does not leave marks
- Wet odour trap with swivel elbow

Scope of supply

- Assembly kit
- Chrome-plated stainless steel outlet grid
- Chrome-plated plastic control knob
- Chrome-plated plastic plug
- Waste and trap body with overflow
- Profiled seal
- Odour trap of polypropylene, thermally and chemically resistant, longitudinally welded

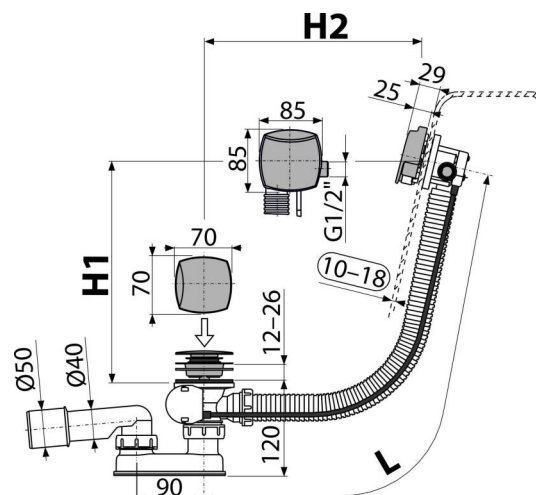

Order number, Logistic information

Code	EAN	Weight (piece packing palett)	Dimensions (piece packing)	Quantity (packing palett)
A565CRM3-120	8595580523916	120 mm 1,02 12,30 216,7 kg	380x95x210 595x435x395 mm	12 192 pcs

Warranty
2/3 years *

Norms
EN 274

Technical specifications

- Resistance of odour trap against the pressure 588 Pa
- Flow rate 48,6 l/min
- Overflow flow rate 33,6 l/min
- Thermal resistance 95 °C
- Odour trap 50 mm