

CPZ-1150

Linear shower drain

Application

- For wheelchair access
- For drainage of floor-level showers
- For installation into open spaces or near the wall of the shower area
- For full grids, grid FLOOR for embedding tiles and prismatic grid GAP
- For indoor use

Features

- The collar and trap are protected by foil, and the channel itself by a polystyrene insert
- Trap material: polypropylene
- Material of drainage channel: stainless steel AISI 304, DIN 1.4301
- Mechanically cleanable trap up to the waste pipe
- Possibility to buy a combined odour trap
- Linear drain from stainless steel (hardened by pickling, passivation and electrochemical polishing)
- For inserting full grids – stainless steel, tempered glass, synthetic stone, grid for embedding tiles and prismatic grid
- Self-adhesive tape for quality waterproofing
- Trap firmly connected to the drain – 100% waterproofing
- Installation height from 95 mm
- Adjustable height
- The high flow rate is achieved due to the double compartment trap system
- 25 years guarantee

Scope of supply

- Fixing hardware for anchoring the adjustable legs: screw M6x12 – 2 pcs
- Fixation set: screws Ø6x50 – 2 pcs, dowels Ø10 – 2 pcs
- Installation channel cover
- The collar and the odour trap inlet are covered by the protective foil
- Self-adhesive waterproofing tape
- The shower drain is assembled with the odour trap

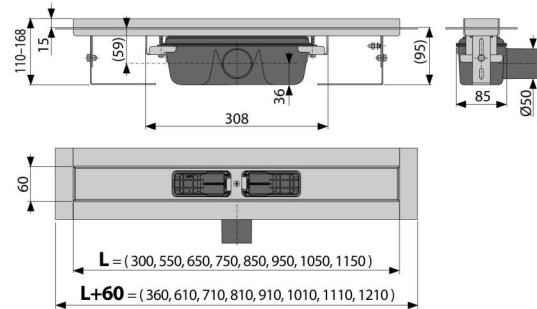

Order number, Logistic information

Code	EAN	Weight (piece packing palett)	Dimensions (piece packing)	Quantity (packing palett)
CPZ-1150	8595580528164	4,74 56,86 190,6 kg	1220x135x170 mm	12 36 pcs
Warranty 2/25 years	Norms EN 1253			

Technical specifications

- Total installation height 110-168 mm
- Minimum thickness of concrete 95 mm
- Resistance of odour trap against the pressure 982 Pa
- Waste pipe diameter 50 mm
- Flow rate 60-68,8 l/min
- Load class K3 300 kg
- Odour trap 50 mm