

APZ111-850L Antivandal Low

Shower drain Antivandal with grid

Application

- For wheelchair access
- For sites with limited floor height
- For drainage of floor-level showers
- For installation into open spaces or near the wall of the shower area
- For indoor use
- For public areas

Features

- The collar and trap are protected by foil, and the channel itself by a polystyrene insert
- Trap material: polypropylene
- Mechanically cleanable trap up to the waste pipe
- Linear drain from stainless steel (hardened by pickling, passivation and electrochemical polishing)
- Grid BUBLE is attached to the drain body using screws so that it can not be removed without special tools
- Grid is included in packaging
- Self-adhesive waterproofing tape for quality waterproofing
- The trap is firmly connected to the drain channel - 100% waterproofing
- Installation height from 55 mm
- Adjustable height
- The high flow rate is achieved due to the double compartment trap system
- 25 years guarantee

Scope of supply

- Fixing hardware for fixing the grid: screw M5x10 x 2 pcs
- Anchoring set for fixing the adjustable legs: screw M6x12 - 2 pcs
- Installation channel cover
- Anchoring set: screw Ø6x50 - 2 pcs, dowel Ø10 - 2 pcs
- The collar and the odour trap inlet are covered by the protective foil
- Perforated stainless steel grid BUBLE
- Self-adhesive waterproofing tape
- The shower drain is assembled with the odour trap

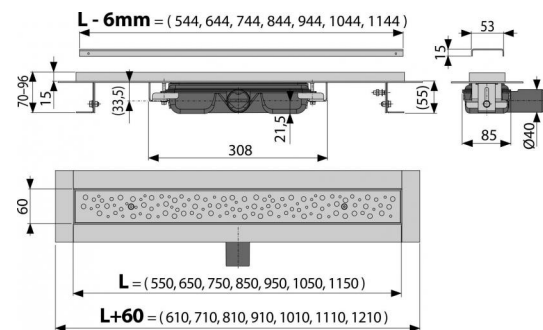

Order number, Logistic information

Code	EAN	Weight (kus packing palett)	Dimensions (piece packing)	Quantity (packing palett)
APZ111-850L	8595580530181	850 mm 4,2584 0,0000 0,0000 kg	900x135x170 mm	12 36 pcs

Guarantee	Customs code	Norms
2/25 years	39229000	EN 1253

Technical specifications

- Total installation height 70-96 mm
- Minimum thickness of concrete 55 mm
- Resistance of odour trap against the pressure 575 Pa
- Waste pipe diameter 40 mm
- Flow rate 32 l/min
- Load class K3 300 kg
- Odour trap 28 mm