

ADZ-P003

End cap for drainage channel 75 mm, galvanized steel

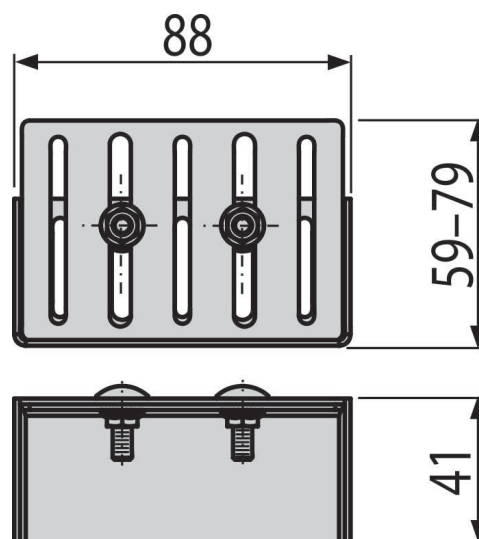

Application

For drainage channel

Features

- Material: galvanized steel
- To end the drainage channel

Scope of supply

- End cap
- Screws and nuts for fixing the end cap to the drain channel 2 pcs

Order number, Logistic information

Code	EAN	Weight (piece packing palett)	Dimensions (piece packing)	Quantity (packing palett)
ADZ-P003	8595580548131	0,14 0,14 - kg	88x59x41 mm	1 - pc

Warranty

2/2 years *