

# APZ16-750 Wall

Shower drain with an edge for full grids and fixed vertical flange to the wall

## Application

- For wheelchair access
- For drainage of floor-level showers
- For installation directly to the wall
- For full grids, grid FLOOR for embedding tiles and prismatic grid GAP
- For indoor use

## Features

- The collar and trap are protected by foil, and the channel itself by a polystyrene insert
- Trap material: polypropylene
- Shower drain material: stainless steel 2 mm, AISI 304, DIN 1.4301
- Mechanically cleanable trap up to the waste pipe
- Possibility to buy a combined odour trap
- Linear drain from stainless steel (hardened by pickling, passivation and electrochemical polishing)
- For inserting full grids – stainless steel, tempered glass, synthetic stone, grid for embedding tiles and prismatic grid
- Self-adhesive tape for quality waterproofing
- Trap firmly connected to the drain – 100% waterproofing
- Installation height from 95 mm
- Adjustable height
- The high flow rate is achieved due to the double compartment trap system
- 25 years guarantee

## Scope of supply

- Anchoring set: screw  $\varnothing 6 \times 50$  – 2 pcs, dowel  $\varnothing 10$  – 2 pcs, screw  $\varnothing 4.2 \times 38$  – 3 pcs, dowel  $\varnothing 8$  – 3 pcs
- Installation trough cover - polystyrene
- Protective foil covering for the drain edges and odour trap
- Protective film for trap inlet
- Self-adhesive waterproofing tape
- The shower drain is assembled with the odour trap

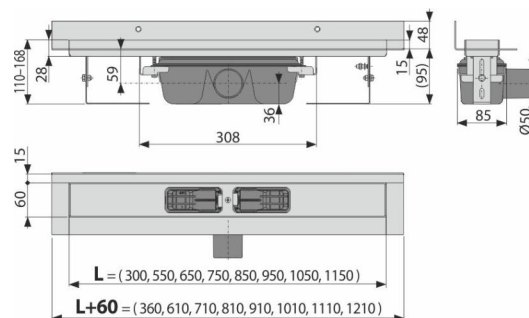

## Order number, Logistic information

Code	EAN	Weight (piece   packing   palett)	Dimensions (piece   packing)	Quantity (packing   palett)
APZ16-750	8595580553043	750 mm 4,19   33,53   120,6 kg	820×205×160   mm	8   24 pcs
<b>Warranty</b> 2/25 years *	<b>Norms</b> EN 1253			

## Technical specifications

- Total installation height 110-168 mm
- Minimum thickness of concrete 95 mm
- Resistance of odour trap against the pressure 982 Pa
- Waste pipe diameter 50 mm
- Flow rate 60-68,8 l/min
- Load class K3 300 kg
- Odour trap 50 mm