

APZ116-550 Wall Low

Shower drain with an edge for full grids and fixed vertical flange to the wall

Application

- For wheelchair access
- For drainage of floor-level showers
- For installation directly to the wall
- For full grids, grid FLOOR for embedding tiles and prismatic grid GAP
- For indoor use

Features

- The collar and trap are protected by foil, and the channel itself by a polystyrene insert
- Trap material: polypropylene
- Shower drain material: stainless steel 2 mm, AISI 304, DIN 1.4301
- Mechanically cleanable trap up to the waste pipe
- Possibility to buy a combined odour trap
- Linear drain from stainless steel (hardened by pickling, passivation and electrochemical polishing)
- For inserting full grids – stainless steel, tempered glass, synthetic stone, grid for embedding tiles and prismatic grid
- Self-adhesive tape for quality waterproofing
- Trap firmly connected to the drain – 100% waterproofing
- Installation height from 65 mm
- Adjustable height
- The high flow rate is achieved due to the double compartment trap system
- 25 years guarantee

Scope of supply

- Anchoring set: screw $\varnothing 6 \times 50$ – 2 pcs, dowel $\varnothing 10$ – 2 pcs, screw $\varnothing 4.2 \times 38$ – 3 pcs, dowel $\varnothing 8$ – 3 pcs
- Installation trough cover - polystyrene
- Protective foil covering for the drain edges and odour trap
- Protective film for trap inlet
- Self-adhesive waterproofing tape
- The shower drain is assembled with the odour trap

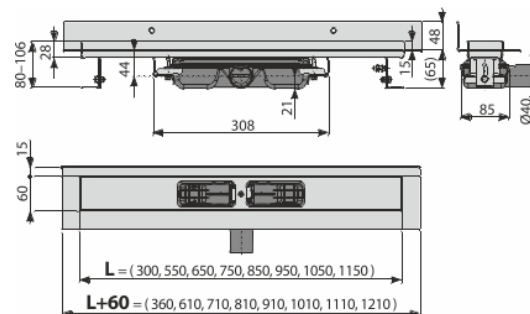

Order number, Logistic information

Code	EAN	Weight (piece packing palett)	Dimensions (piece packing)	Quantity (packing palett)
APZ116-550	8595580553104	550 mm 3,46 27,71 103,1 kg	620x205x160 mm	8 24 pcs

Warranty

2/25 years *

Technical specifications

- Total installation height 80-106 mm
- Minimum thickness of concrete 65 mm
- Resistance of odour trap against the pressure 575 Pa
- Waste pipe diameter 40 mm
- Flow rate 35 l/min
- Load class K3 300 kg
- Odour trap 28 mm