

A420

Wash-basin waste and trap DN32 with plastic grid DN63

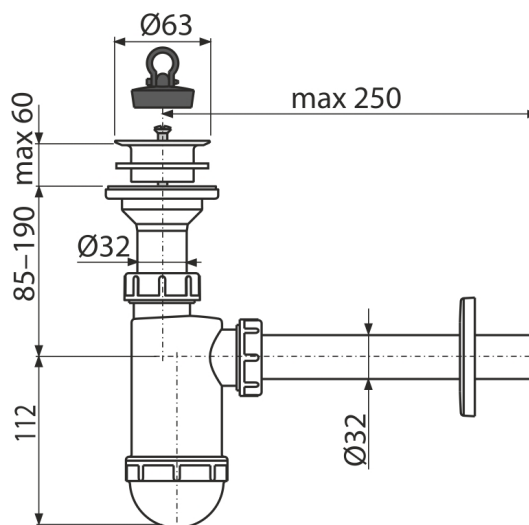

Application

For wash-basin

Features

- Material: polypropylene
- Connection to waste pipe Ø32 mm

Scope of supply

- Plastic outlet grid
- Plastic rosette
- Waste and trap body
- PVC plug

Order number, Logistic information

Code	EAN	Weight (piece packing palett)	Dimensions (piece packing)	Quantity (packing palett)
A420	8595580556532	0,27 6,86 212,0 kg	220x80x140 590x240x390 mm	25 700 pcs

Warranty

2/3 years *

Norms

EN 274

Technical specifications

- Flow rate 38 l/min
- Thermal resistance 95 °C
- Odour trap 58 mm