

P145

Combined odour trap SMART for APZ-S12

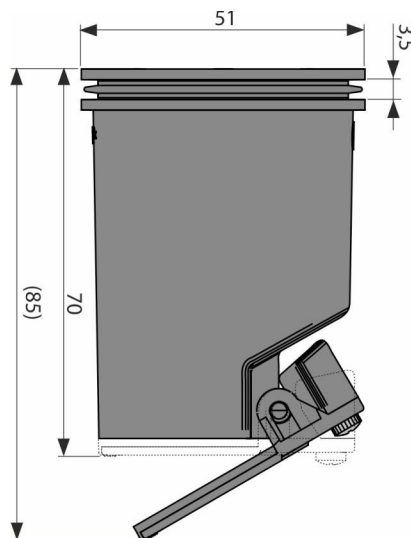

Application

For areas that are expected to have low usage of the shower enclosure
For trap APZ-S12 and floor drain APV130

Features

- Material: polypropylene resistant to mechanical, chemical and thermal damage
- Mechanical closure and the water column prevent the penetration of odours from the sewer

Order number, Logistic information

Code	EAN	Weight (piece packing palett)	Dimensions (piece packing)	Quantity (packing palett)
P145	8595580562311	0,05 0,05 - kg	51x51x70 - mm	1 - pc

Warranty
2/2 years *

Customs code
39269097