

APZ15-750 Marble

Shower drain without edge with grid for embedding tiles

Application

- For wheelchair access
- For drainage of floor-level showers
- For installation into open spaces or near the wall of the shower area
- For use of various types of floor coverings
- For indoor use

Features

- Elegant design thanks to the grid for embedding tiles without a stainless steel frame
- The collar and trap are protected by foil, and the channel itself by a polystyrene insert
- Trap material: polypropylene
- Shower drain material: stainless steel 2 mm, AISI 304, DIN 1.4301
- Mechanically cleanable trap up to the waste pipe
- Possibility to buy a combined odour trap
- Linear drain from stainless steel (hardened by pickling, passivation and electrochemical polishing)
- Self-adhesive tape for quality waterproofing
- Trap firmly connected to the drain – 100% waterproofing
- Installation height from 100 mm
- Adjustable height
- The high flow rate is achieved due to the double compartment trap system
- 25 years guarantee

Scope of supply

- Dismantling hook
- Fixation set: screws $\varnothing 6 \times 50$ – 2 pcs, dowels $\varnothing 10$ – 2 pcs
- Installation trough cover - polystyrene
- Protective foil covering for the drain edges and odour trap
- Protective film for trap inlet
- Grid for gluing various types of floor coverings
- Template for cutting tiles on the grid
- Self-adhesive waterproofing tape
- The shower drain is assembled with the odour trap

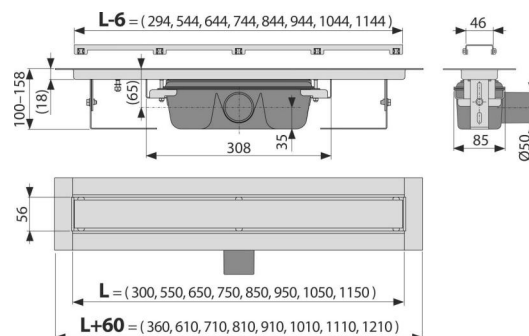

Order number, Logistic information

Code	EAN	Weight (piece packing palett)	Dimensions (piece packing)	Quantity (packing palett)
APZ15-750	8595580565558	750 mm 5,06 40,51 141,5 kg	820x205x160 mm	8 24 pcs

Warranty	Customs code	Norms
2/25 years *	39229000	EN 1253

Technical specifications

- Total installation height 100-158 mm
- Minimum thickness of concrete 100 mm
- Resistance of odour trap against the pressure 982 Pa
- Waste pipe diameter 50 mm
- Flow rate 60-68,8 l/min
- Load class K3 300 kg
- Odour trap 50 mm