

A505CKM-80

Bath CLICK/CLACK waste and trap, metal

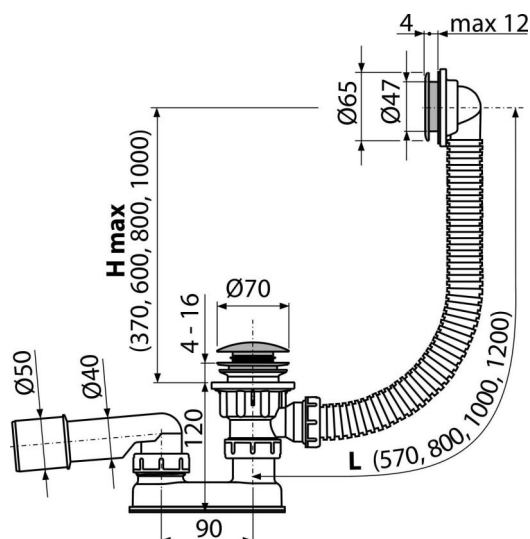

Application

To drain the water from the bath to the waste
For bathtubs with drain outlet Ø52 mm
For standard size bathtubs

Features

- The length of the bathtub trap 80 cm
- Overflow flexi pipe
- Easy clean trap – thanks to completely removable waste outlet
- Closing waste by CLICK/CLACK
- Bath waste and overflow system
- Wet odour trap with swivel elbow

Scope of supply

- Waste outlet wrench 6/4"
- Assembly kit
- Chrome-plated metal plug
- Chrome-plated brass outlet
- Chrome-plated plastic overflow grid
- Waste and trap body with overflow
- Profiled seal
- Odour trap of polypropylene, thermally and chemically resistant, longitudinally welded

Order number, Logistic information

Code	EAN	Weight (piece packing palett)	Dimensions (piece packing)	Quantity (packing palett)
A505CKM-80	8595580567019	80 mm 0,66 13,13 230,0 kg	330x100x220 mm	20 320 pcs

Warranty

2/3 years *

Norms

EN 274

Technical specifications

- Resistance of odour trap against the pressure 588 Pa
- Flow rate 48,6 l/min
- Overflow flow rate 42 l/min
- Thermal resistance 95 °C
- Odour trap 50 mm