

A443P-DN50/40-ECO-1700

Sink trap with coupling nut 6/4" and connector

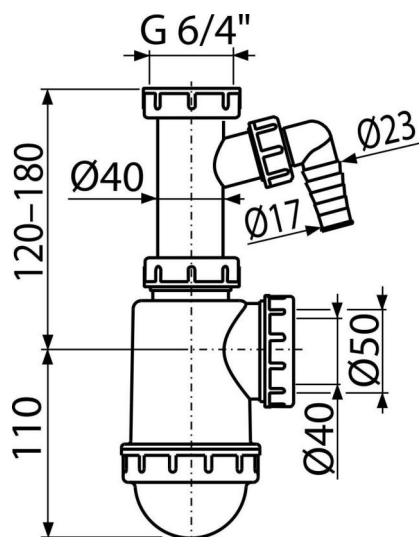

Application

For sink

Features

- Material: recycled polypropylene
- Low carbon footprint
- With connector for washing machine or dishwasher
- Made in Czech Republic
- Zero waste production process
- Waste outlet ready for connection to drain pipe $\varnothing 50$ mm or $\varnothing 40$ mm

Scope of supply

- Nut to connect sink waste 6/4"
- Sink trap body with connector

Order number, Logistic information

Code	EAN	Weight (piece packing palett)	Dimensions (piece packing)	Quantity (packing palett)
A443P-DN50/40-ECO-1700	8595580582227	0,26 6,45 200,5 kg	260x90x140 590x240x390 mm	25 700 pcs

Warranty

2/3 years

Norms

EN 274

Technical specifications

- Hose connector 17-23 mm
- Flow rate 44 l/min
- Thermal resistance 95 °C
- Odour trap 53 mm